

К формулярной ведомости
огневых сооружений **109 ОПАБ.**
по состоянию на **30^е июня 1943 г.**

К. № 20556
1.07.43

“СЕКРЕТНО”
ЭКЗЕМПЛЯР
ЕДИНСТВЕННЫЙ

11

**ЭСКИЗЫ ПЛАНОВ
ОГНЕВЫХ СООРУЖЕНИЙ
НА РУБЕЖЕ **109** ОПАБ**

79-я УКРЕП. РАЙОН
К ВХОД. № 3080
"1" июля 1943 г.

от 1043

29

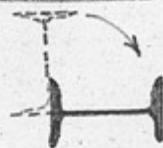
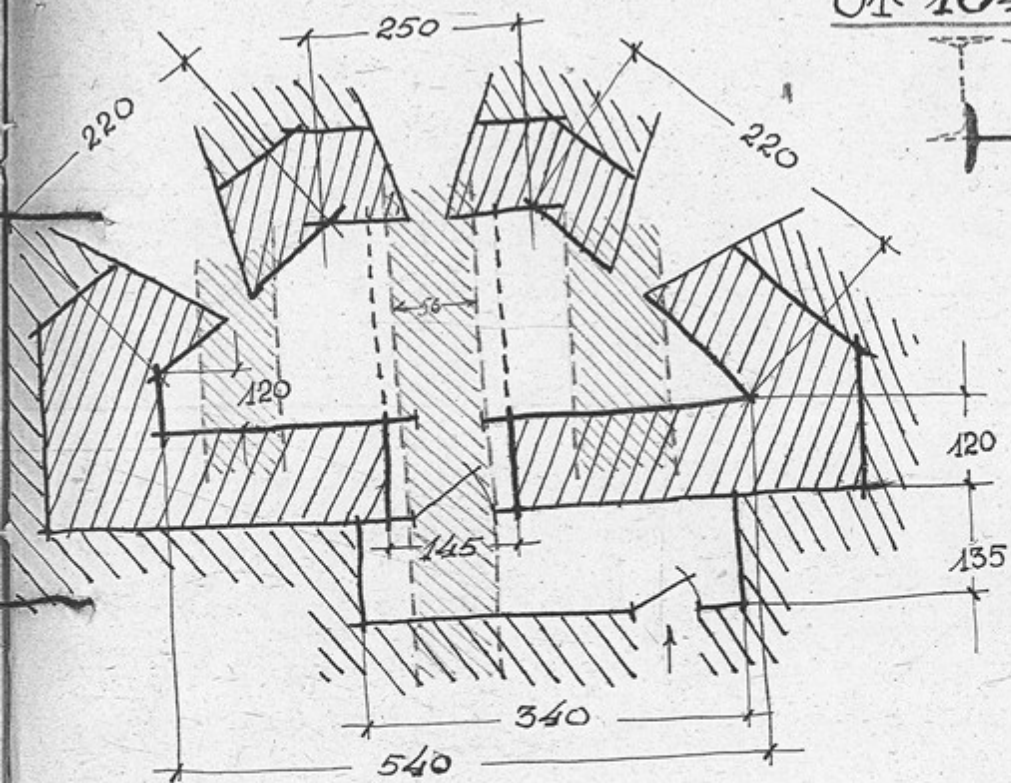

Двубровная бабка № 56
лежащая

подпорная
стенка

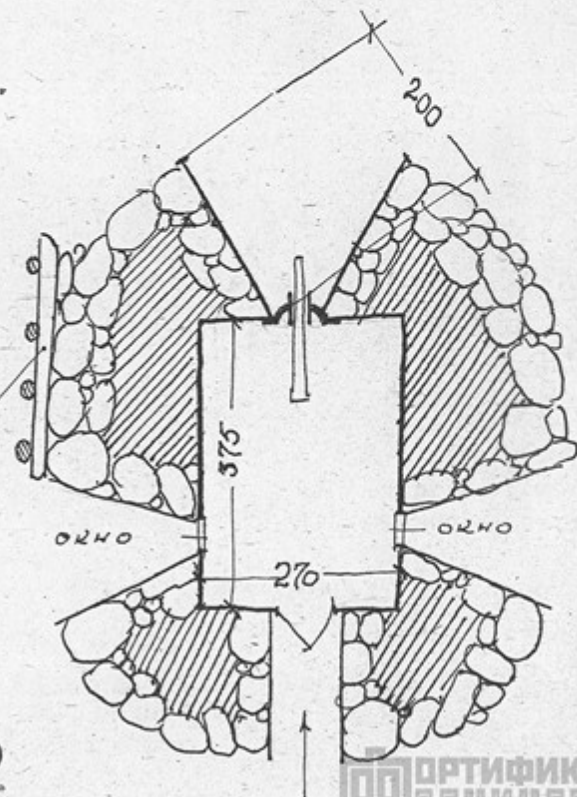

от 1049

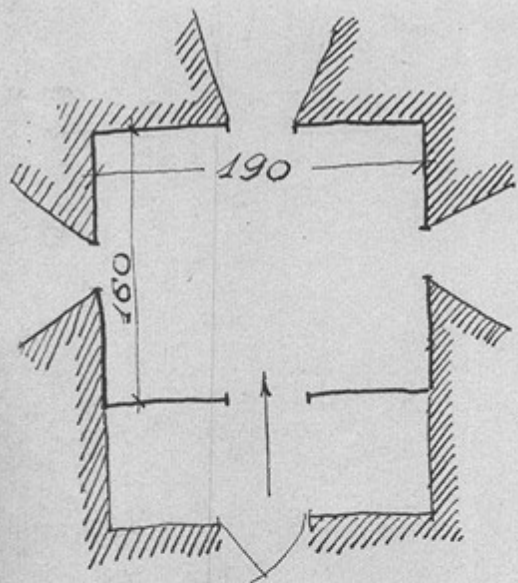

ОТ 1045
 -"- 1040
 -"- 1078

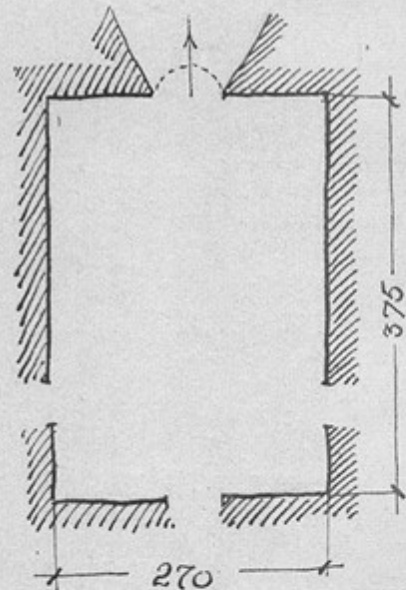

ОТ 1008
 -"-

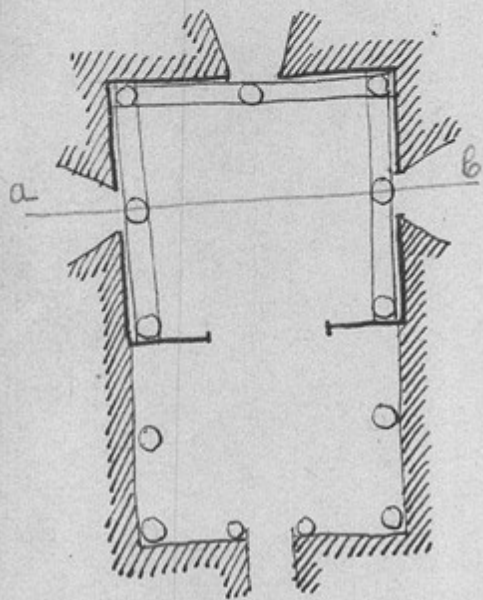

ОТ 1035

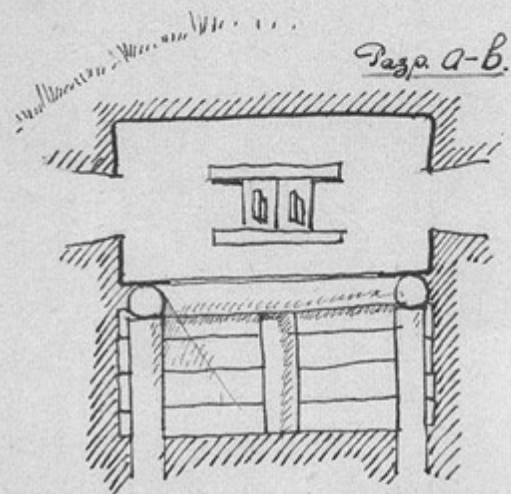

от - 1036

6

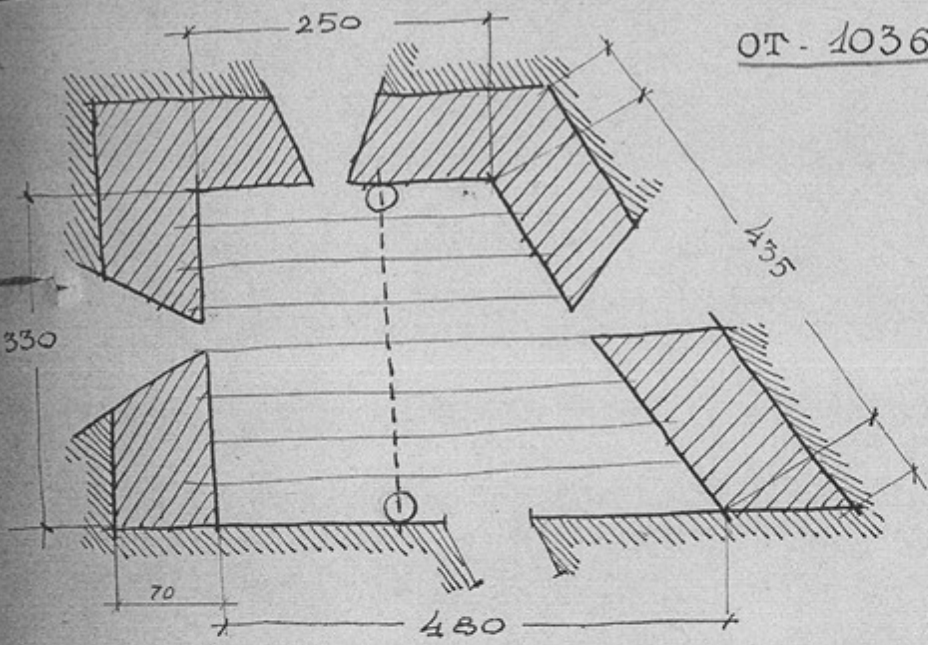

от 1039

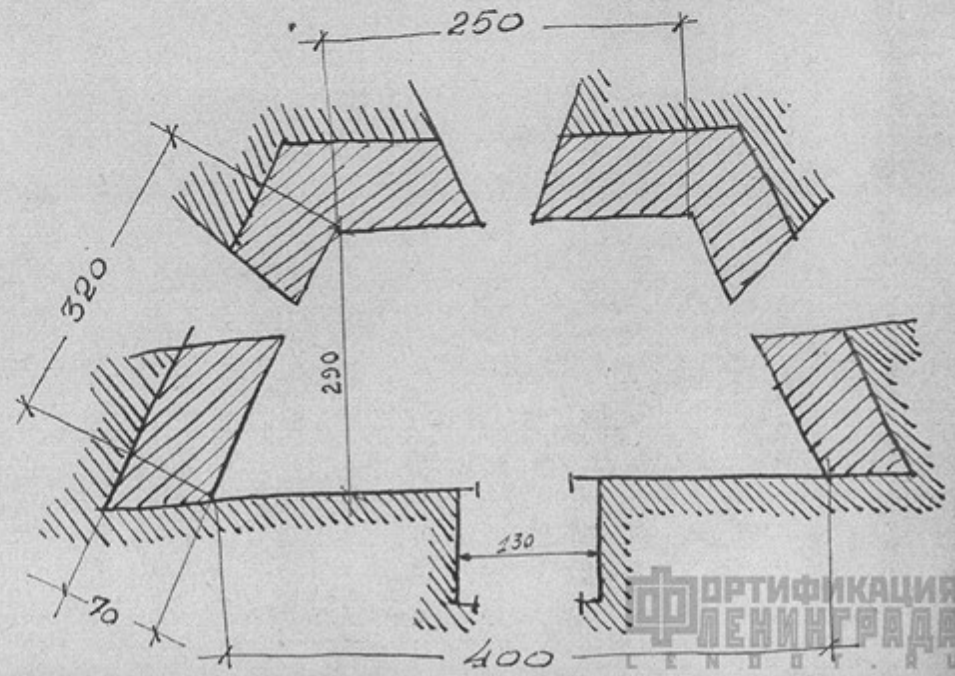

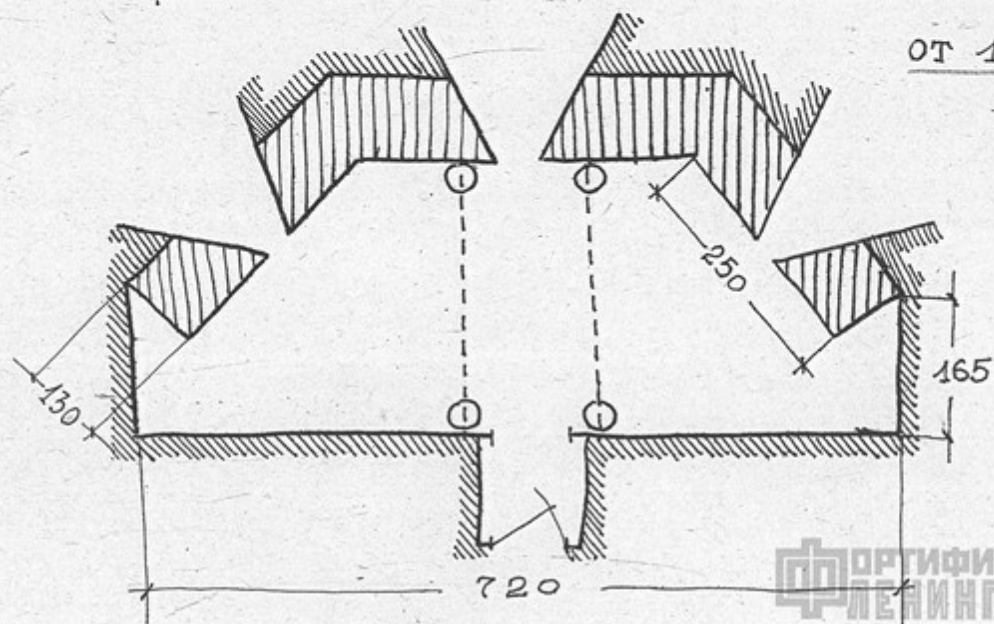
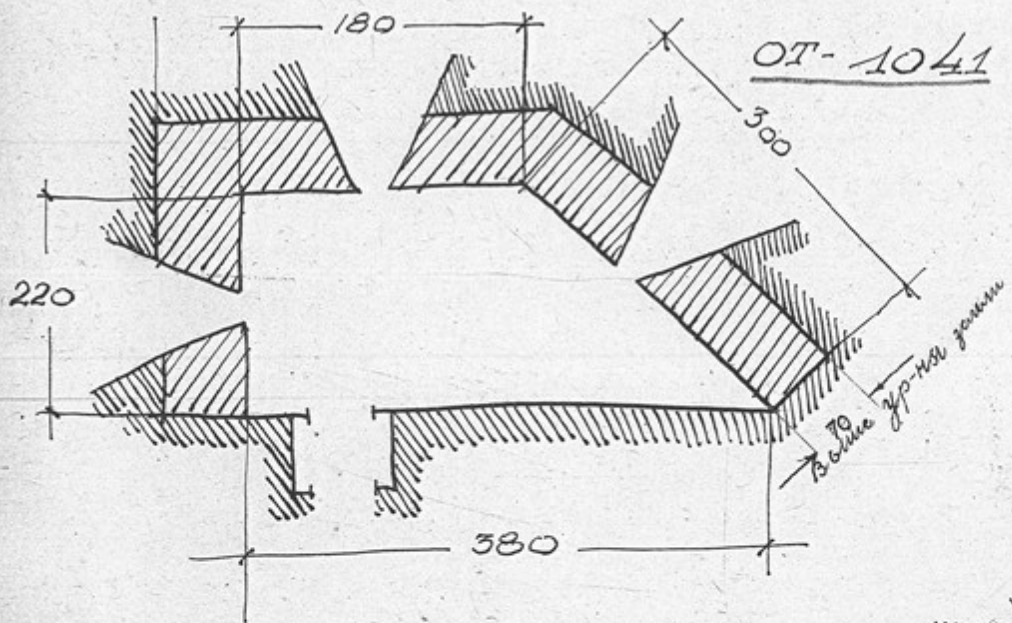

ОТ 1084.

14

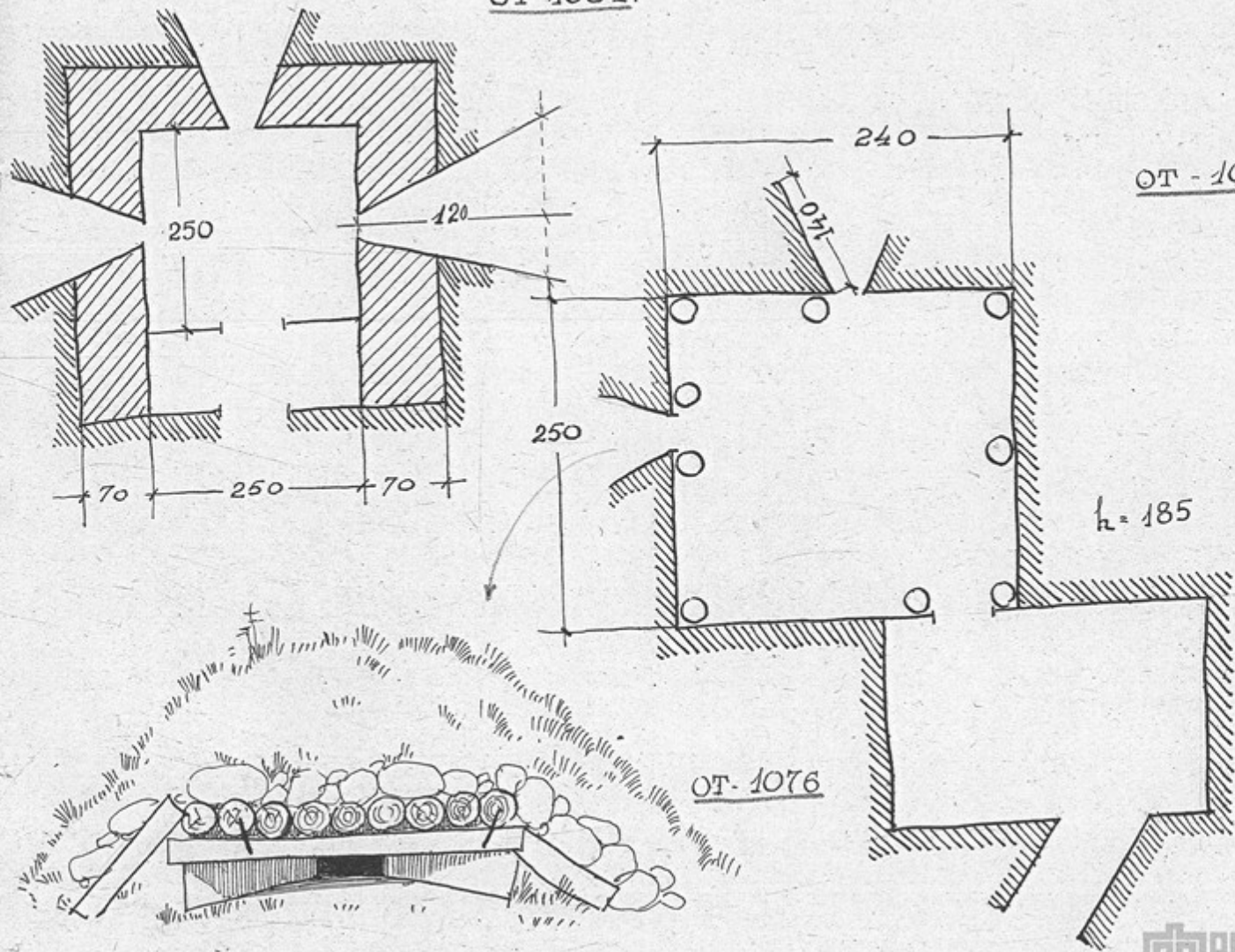

ОТ - 1076

$h = 185$

ОТ - 1076

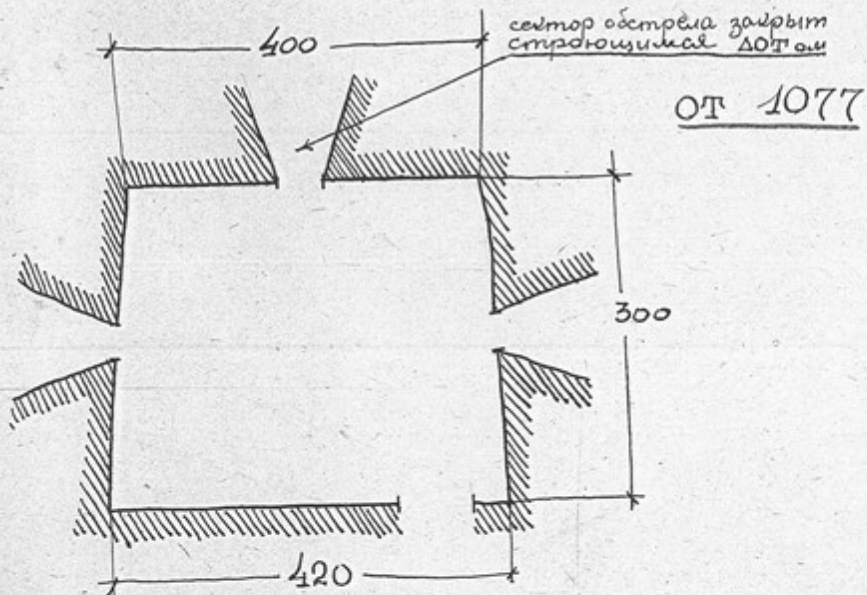

ОТ 1077

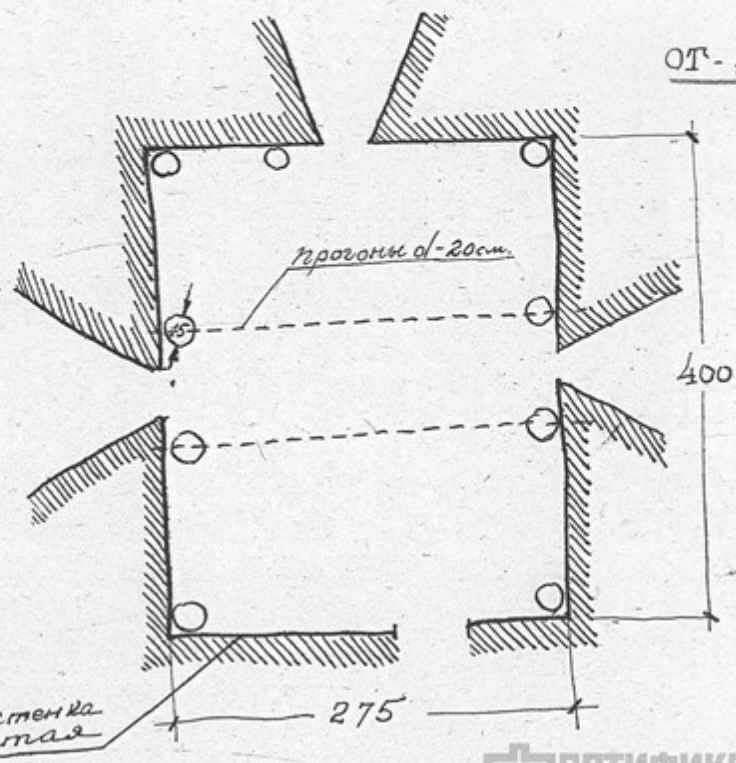

ОТ ~ 1115.

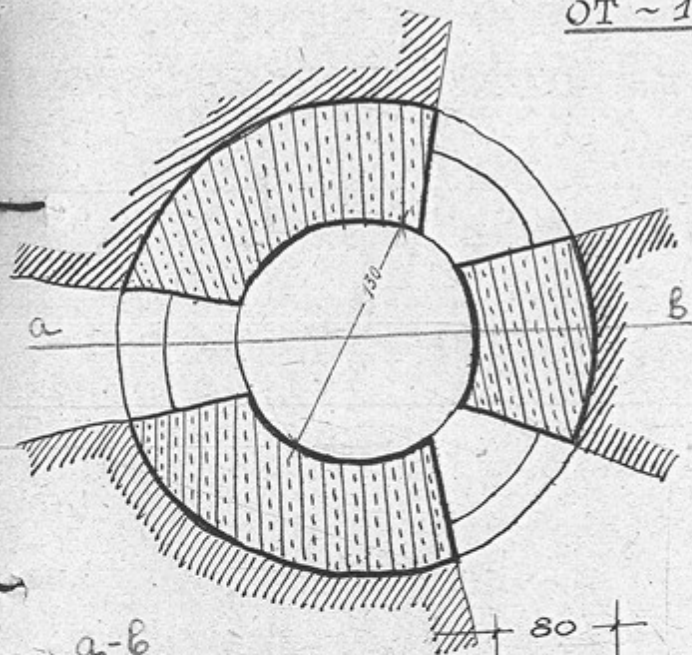

a-b

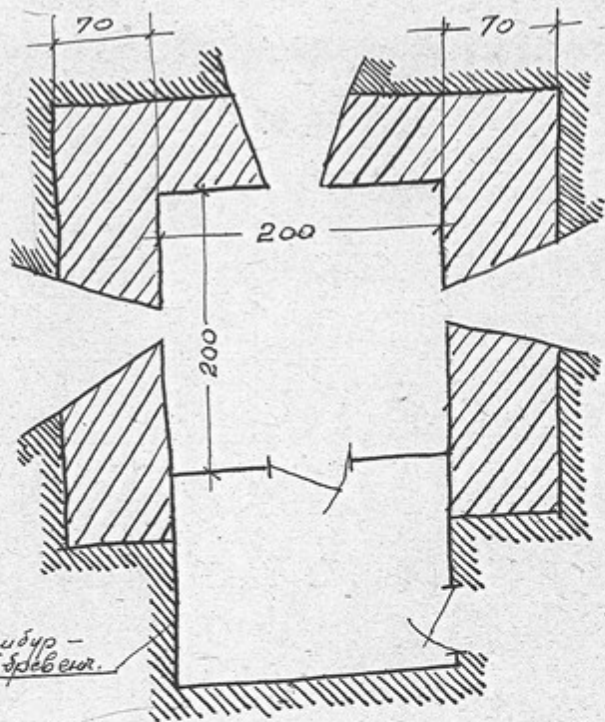
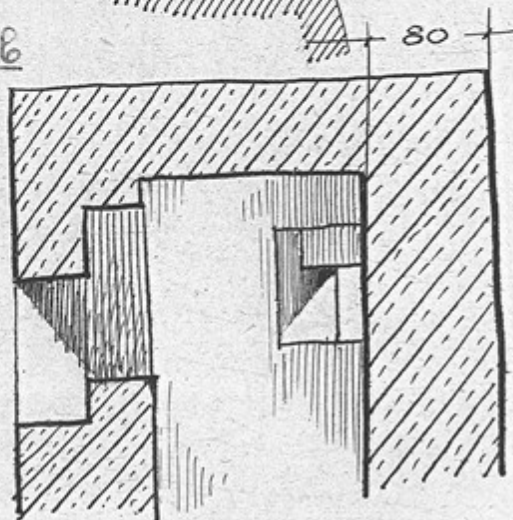

ташбур -
сруб дерева.

ОТ - 1116

ОТ ~ 1108.

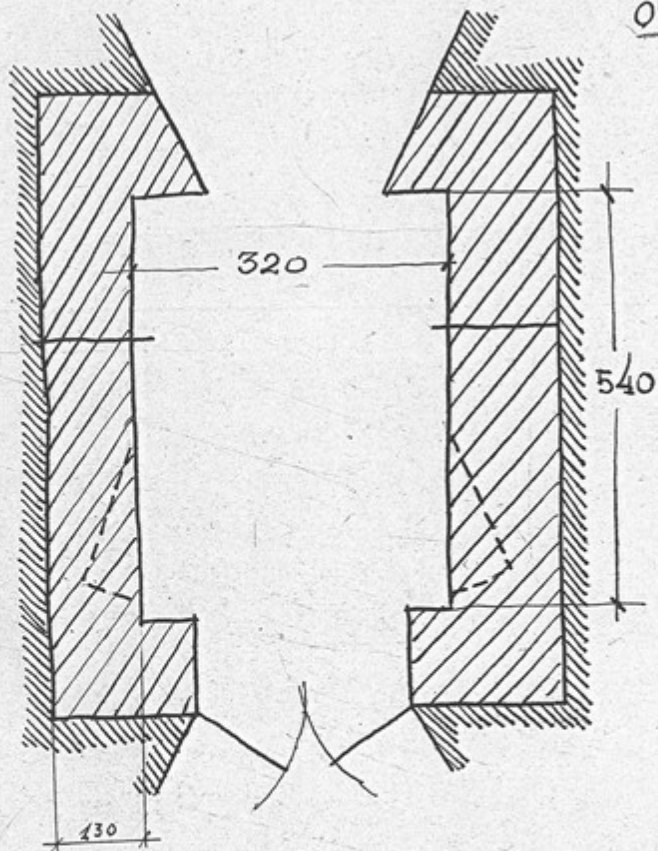

ОТ - 1113
- " - 1114

*лобовой броне-
щит. 60т*

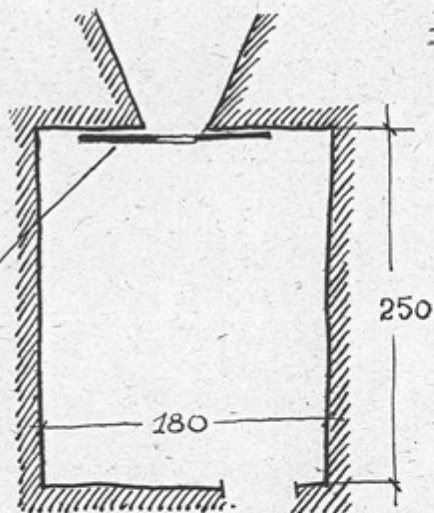

ОТ 1117.

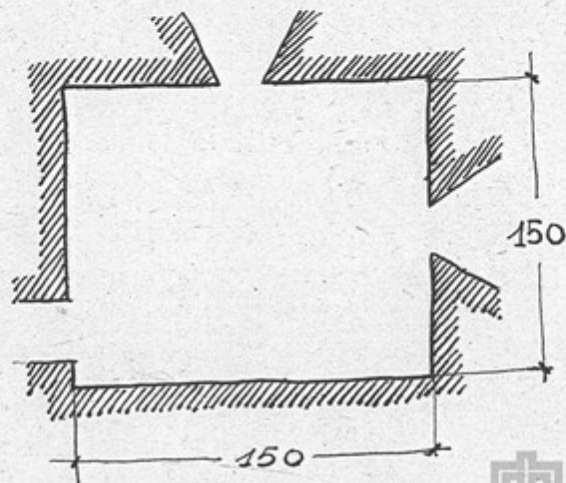

от ~ 1118.

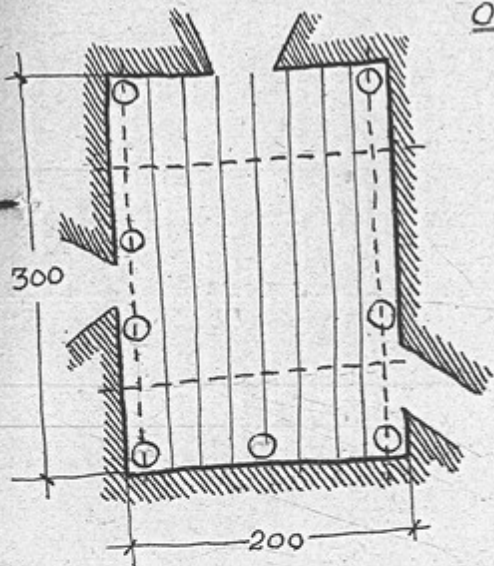

от 1119
16

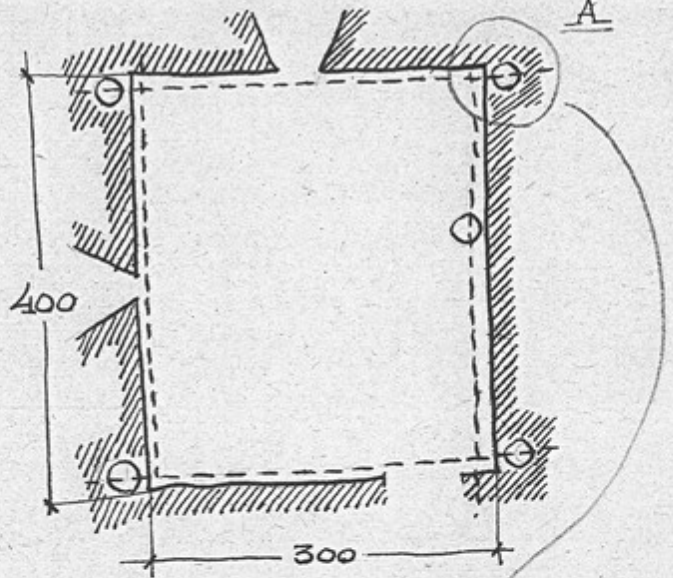

ДЕТАЛЬ А

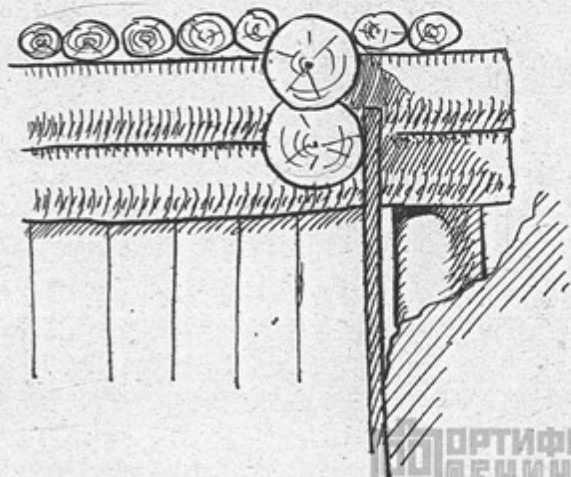

ОТ- 1120

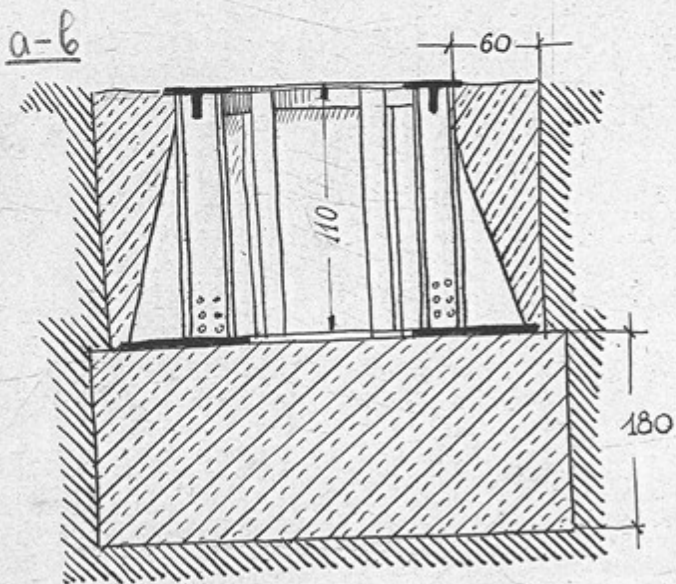
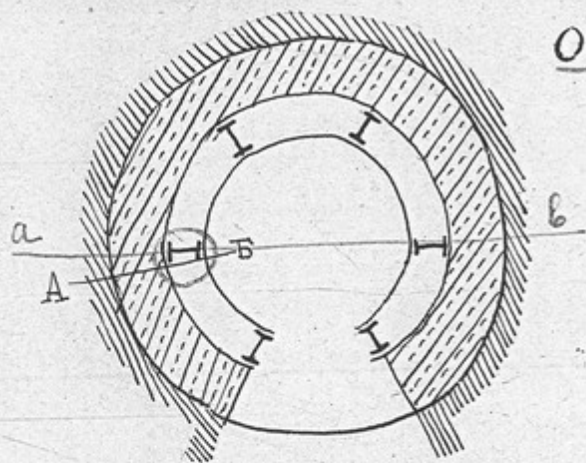

ОТ. 1112

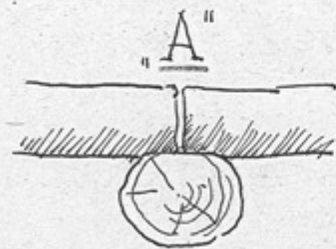
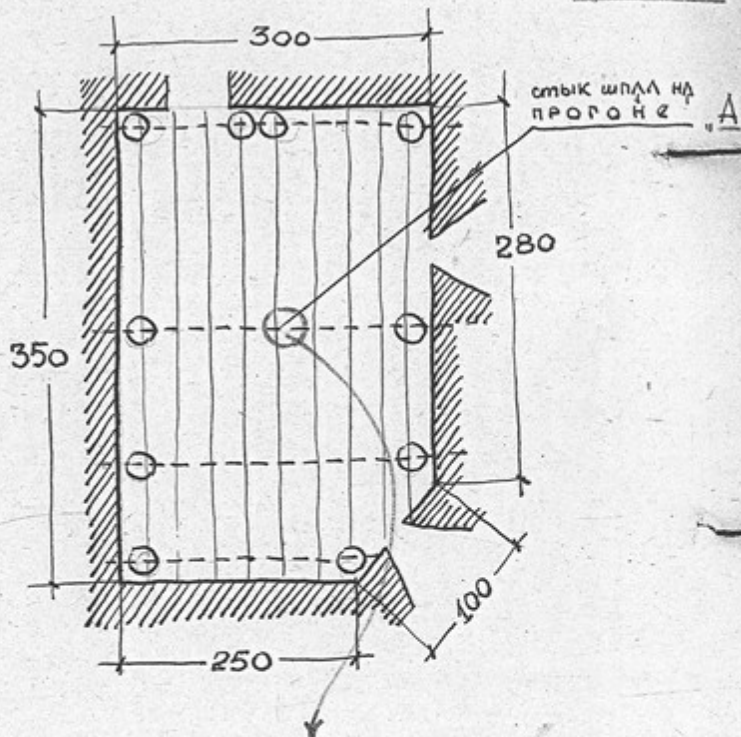

OT 1161

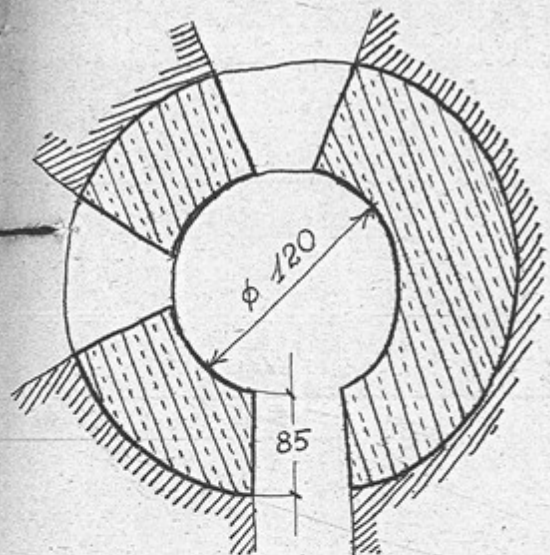

OT - 328

17

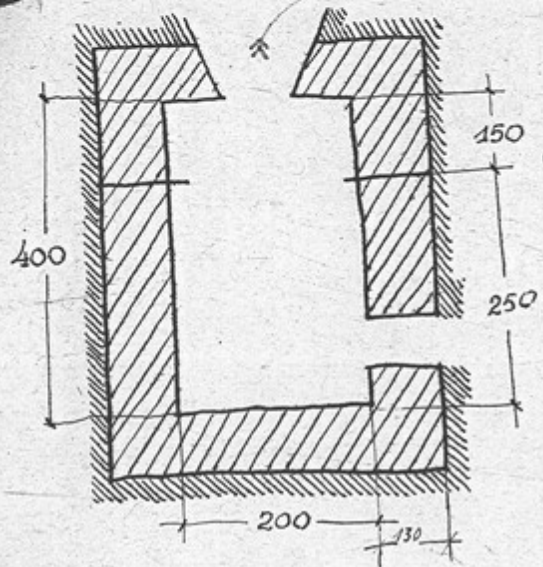
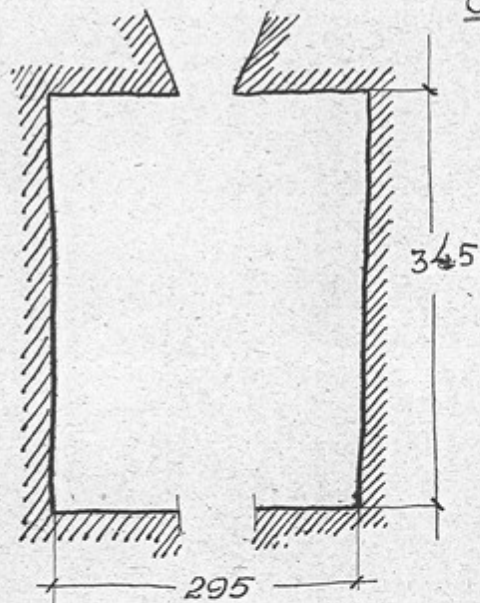

OT 336.

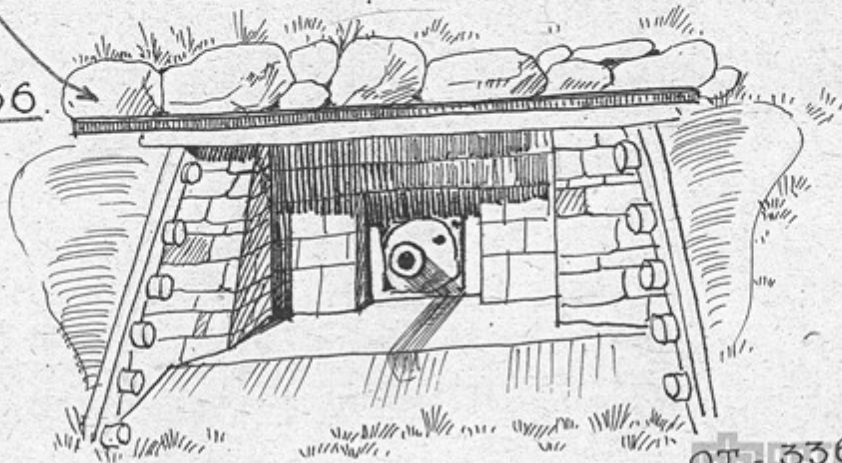

от 340.

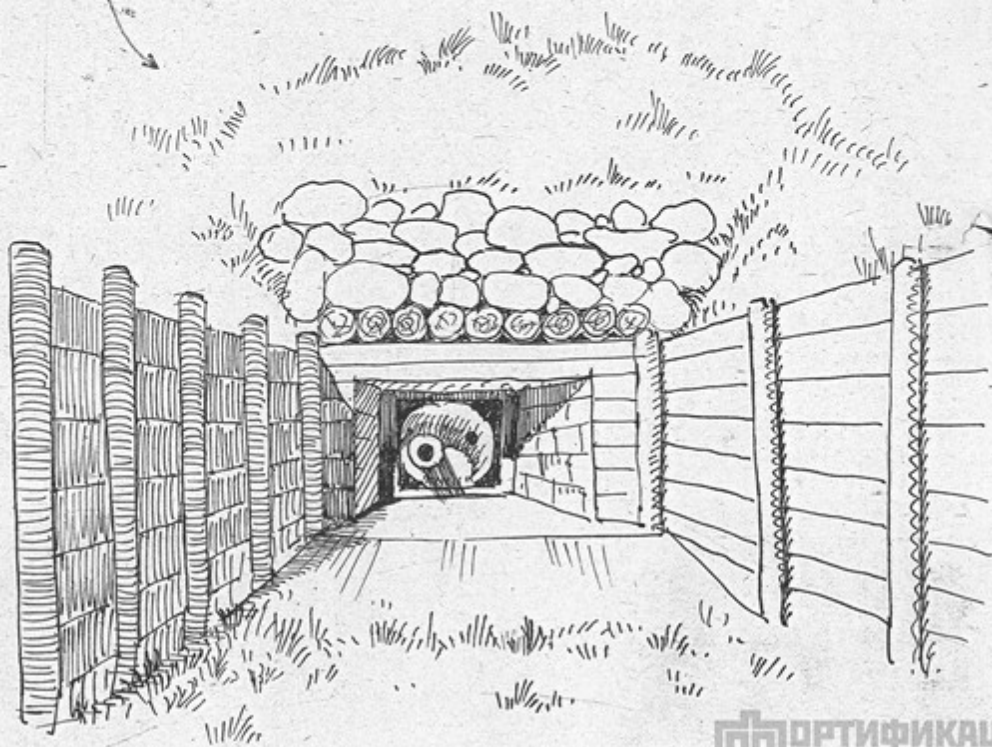
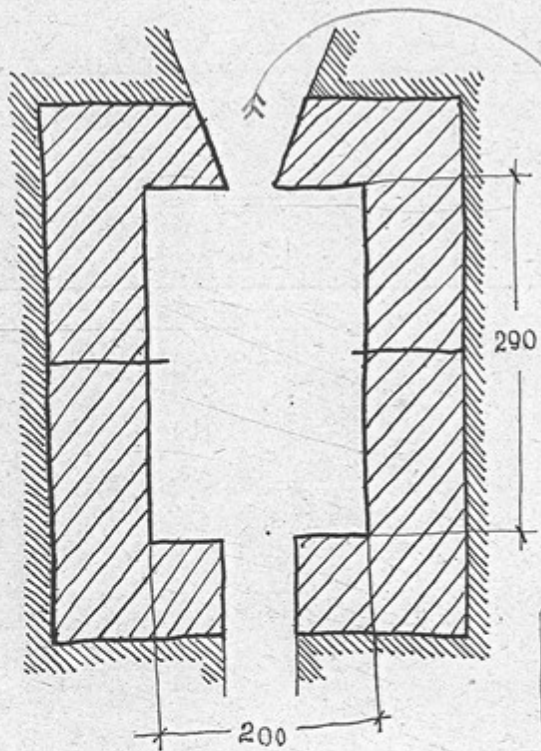

от 1159

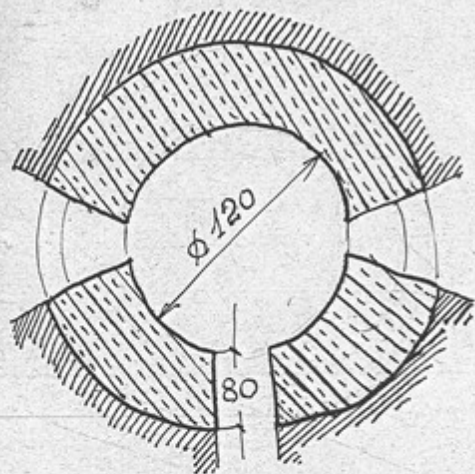

от 1158

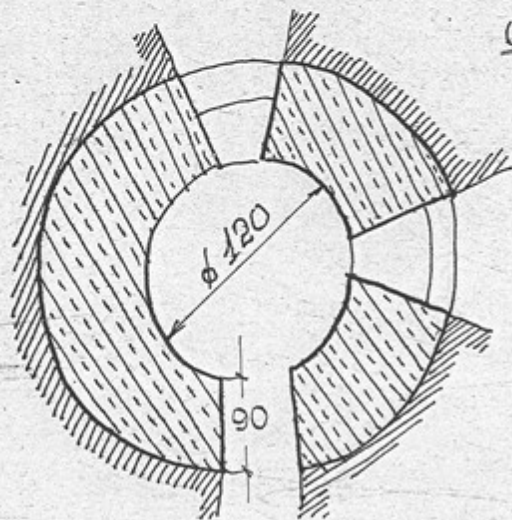

от 1202

" 1247.

18

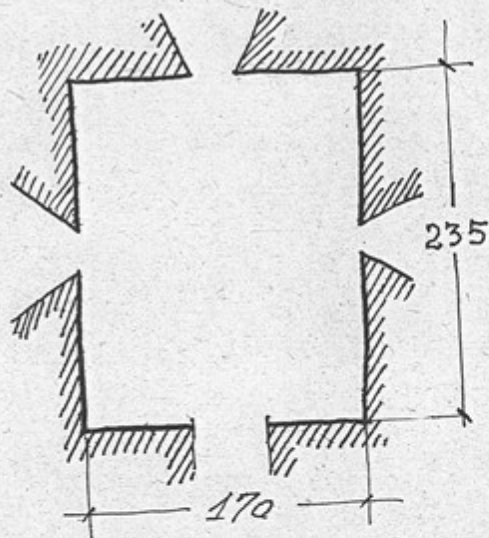

от 1196.

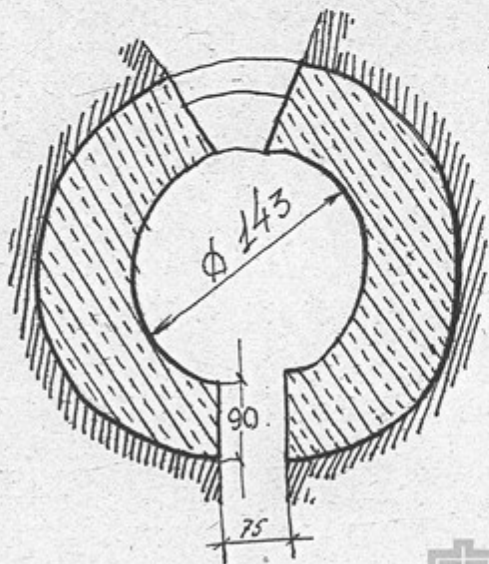

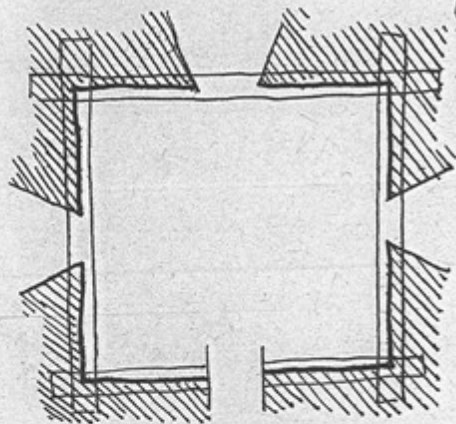

от 1272
1273

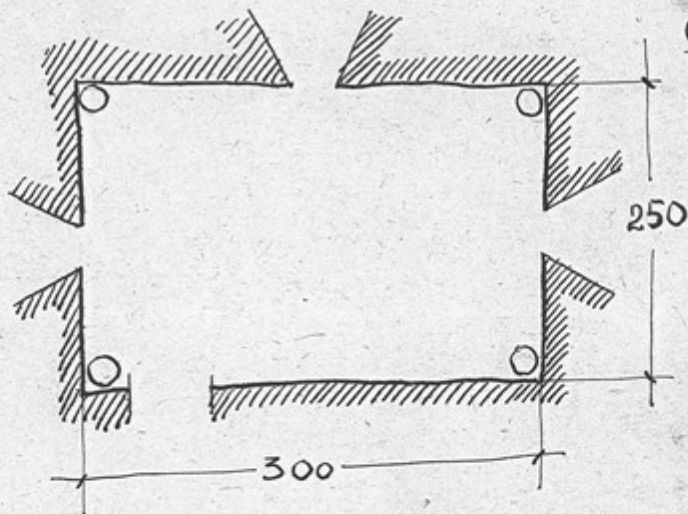

от 1164